

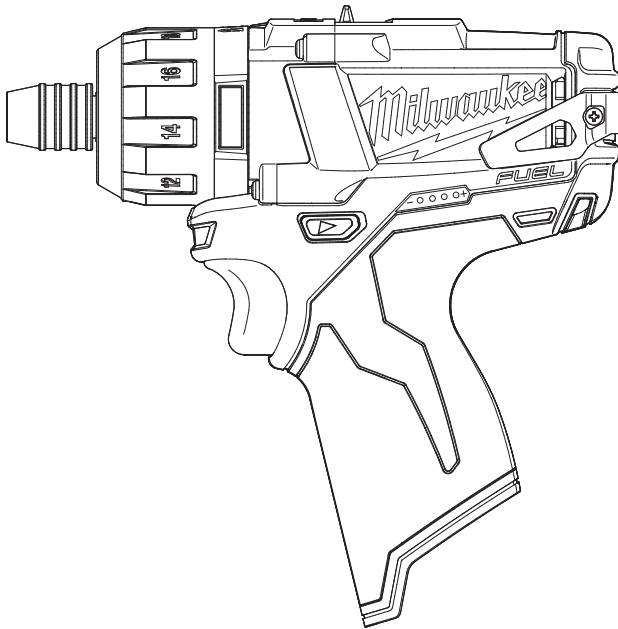

## OPERATOR'S MANUAL

**Cat. No.  
M12 CD**



### **M12™ FUEL™ 1/4" HEX 2-SPEED SCREWDRIVER**

***TO REDUCE THE RISK OF INJURY, USER MUST READ AND UNDERSTAND OPERATOR'S MANUAL.***

## GENERAL POWER TOOL SAFETY WARNINGS



**WARNING** READ ALL SAFETY WARNINGS AND ALL INSTRUCTIONS. Failure to follow the warnings and instructions may result in electric shock, fire and/or serious injury. **Save all warnings and instructions for future reference.** The term "power tool" in the warnings refers to your mains-operated (corded) power tool or battery-operated (cordless) power tool.

### WORK AREA SAFETY

- **Keep work area clean and well lit.** Cluttered or dark areas invite accidents.
- **Do not operate power tools in explosive atmospheres, such as in the presence of flammable liquids, gases or dust.** Power tools create sparks which may ignite the dust or fumes.
- **Keep children and bystanders away while operating a power tool.** Distractions can cause you to lose control.

### ELECTRICAL SAFETY

- **Power tool plugs must match the outlet. Never modify the plug in any way. Do not use any adapter plugs with earthed (grounded) power tools.** Unmodified plugs and matching outlets will reduce risk of electric shock.
- **Avoid body contact with earthed or grounded surfaces such as pipes, radiators, ranges and refrigerators.** There is an increased risk of electric shock if your body is earthed or grounded.
- **Do not expose power tools to rain or wet conditions.** Water entering a power tool will increase the risk of electric shock.
- **Do not abuse the cord. Never use the cord for carrying, pulling or unplugging the power tool. Keep cord away from heat, oil, sharp edges or moving parts.** Damaged or entangled cords increase the risk of electric shock.
- **When operating a power tool outdoors, use an extension cord suitable for outdoor use.** Use of a cord suitable for outdoor use reduces the risk of electric shock.
- **If operating a power tool in a damp location is unavoidable, use a ground fault circuit interrupter (GFCI) protected supply.** Use of an GFCI reduces the risk of electric shock.

### PERSONAL SAFETY

- **Stay alert, watch what you are doing and use common sense when operating a power tool. Do not use a power tool while you are tired or under the influence of drugs, alcohol or medication.** A moment of inattention while operating power tools may result in serious personal injury.
- **Use personal protective equipment. Always wear eye protection.** Protective equipment such as dust mask, non-skid safety shoes, hard hat, or hearing protection used for appropriate conditions will reduce personal injuries.
- **Prevent unintentional starting. Ensure the switch is in the off-position before connecting to power source and/or battery pack, picking up or carrying the tool.** Carrying power tools with your finger on the switch or energising power tools that have the switch on invites accidents.

- **Remove any adjusting key or wrench before turning the power tool on.** A wrench or a key left attached to a rotating part of the power tool may result in personal injury.
- **Do not overreach. Keep proper footing and balance at all times.** This enables better control of the power tool in unexpected situations.
- **Dress properly. Do not wear loose clothing or jewellery. Keep your hair, clothing and gloves away from moving parts.** Loose clothes, jewellery or long hair can be caught in moving parts.
- **If devices are provided for the connection of dust extraction and collection facilities, ensure these are connected and properly used.** Use of dust collection can reduce dust-related hazards.

### POWER TOOL USE AND CARE

- **Do not force the power tool. Use the correct power tool for your application.** The correct power tool will do the job better and safer at the rate for which it was designed.
- **Do not use the power tool if the switch does not turn it on and off.** Any power tool that cannot be controlled with the switch is dangerous and must be repaired.
- **Disconnect the plug from the power source and/or the battery pack from the power tool before making any adjustments, changing accessories, or storing power tools.** Such preventive safety measures reduce the risk of starting the power tool accidentally.
- **Store idle power tools out of the reach of children and do not allow persons unfamiliar with the power tool or these instructions to operate the power tool.** Power tools are dangerous in the hands of untrained users.
- **Maintain power tools. Check for misalignment or binding of moving parts, breakage of parts and any other condition that may affect the power tool's operation. If damaged, have the power tool repaired before use.** Many accidents are caused by poorly maintained power tools.
- **Keep cutting tools sharp and clean.** Properly maintained cutting tools with sharp cutting edges are less likely to bind and are easier to control.
- **Use the power tool, accessories and tool bits etc. in accordance with these instructions, taking into account the working conditions and the work to be performed.** Use of the power tool for operations different from those intended could result in a hazardous situation.

### BATTERY TOOL USE AND CARE

- **Recharge only with the charger specified by the manufacturer.** A charger that is suitable for one type of battery pack may create a risk of fire when used with another battery pack.

- **Use power tools only with specifically designed battery packs.** Use of any other battery packs may create a risk of injury and fire.
- **When battery pack is not in use, keep it away from other metal objects, like paper clips, coins, keys, nails, screws or other small metal objects, that can make a connection from one terminal to another.** Shorting the battery terminals together may cause burns or a fire.
- **Under abusive conditions, liquid may be ejected from the battery; avoid contact. If contact accidentally occurs, flush with water. If liquid contacts eyes, additionally seek medical help.** Liquid ejected from the battery may cause irritation or burns.

## **SERVICE**

- **Have your power tool serviced by a qualified repair person using only identical replacement parts.** This will ensure that the safety of the power tool is maintained.

## **SPECIFIC SAFETY RULES**

### **Hammer Drill/Drivers and Drill/Drivers-**

- **Wear ear protect[cb] when impact drilling.** Exposure to noise can cause hearing loss.
- **Use auxiliary handle(s), if supplied with the tool.** Loss of control can cause personal injury.
- **Hold power tool by insulated gripping surfaces, when performing an operation where the cutting #** Xf] ]b[ **accessory may contact hidden wiring.** Cutting/drilling accessory contacting a "live" wire may make exposed metal parts of the power tool "live" and could give the operator an electric shock.

### **Drivers-**

- **Hold power tool by insulated gripping surfaces, when performing an operation where the fastener may contact hidden wiring.** Fasteners contacting a "live" wire may make exposed metal parts of the power tool "live" and could give the operator an electric shock.
- **Maintain labels and nameplates.** These carry important information. If unreadable or missing, contact a *MILWAUKEE*<sup>®</sup> service facility for a replacement.
- **WARNING:** Some dust created by power sanding, sawing, grinding, drilling, and other construction activities contains chemicals known to cause cancer, birth defects or other reproductive harm. Some examples of these chemicals are:
  - lead from lead-based paint
  - crystalline silica from bricks and cement and other masonry products, and
  - arsenic and chromium from chemically-treated lumber.

Your risk from these exposures varies, depending on how often you do this type of work. To reduce your exposure to these chemicals: work in a well ventilated area, and work with approved safety equipment, such as those dust masks that are specially designed to filter out microscopic particles.

## SPECIFICATIONS

Cat. No.	Volts DC	No Load RPM	Capacities			
			Steel	Wood		
				Flat Bit	Auger Bit	Screws (dia.)
M12 CD	12	LO 0-450 HI 0-1700	6.35 mm (1/4")	28.5mm (1-1/8")	25.4mm (1")	10mm (3/8")

### FUNCTIONAL DESCRIPTION

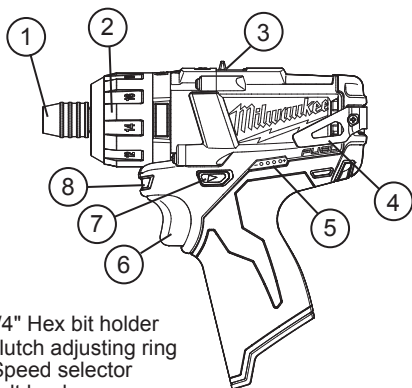

1. 1/4" Hex bit holder
2. Clutch adjusting ring
3. Speed selector
4. Belt hook
5. Fuel Gauge
6. Trigger
7. Control Switch
8. LED

### ASSEMBLY

**⚠ WARNING** Recharge only with the charger specified for the battery. For specific charging instructions, read the operator's manual supplied with your charger and battery.

#### Inserting/Removing the Battery

To **remove** the battery, push in the release buttons and pull the battery pack away from the tool.

To **insert** the battery, slide the pack into the body of the tool. Make sure it latches securely into place.

### SYMBOLOLOGY

<b>V</b>	Volts
— — —	Direct Current
<b>n xxxxmin.<sup>-1</sup></b>	Impacts per Minute Under Load (IPM)
<b>n<sub>0</sub> xxxxmin.<sup>-1</sup></b>	No Load Revolutions per Minute (RPM)
c <b>UL</b> us	Underwriters Laboratories, Inc. United States and Canada

 **WARNING** Always remove battery pack before changing or removing accessories. Only use accessories specifically recommended for this tool. Others may be hazardous.

 **WARNING** To reduce the risk of injury, wear safety goggles or glasses with side shields.

### Fuel Gauge

To determine the amount of charge left in the battery, pull the trigger. The Fuel Gauge will light up for 2-3 seconds.

To signal the end of charge, 1 light on the fuel gauge will flash for 2-3 seconds.

### Installing Bits

Always remove the battery before inserting or removing bits. Select the proper style and size bit for the job.

This driver is intended for use with drill and driver bits with a 1/4" hex shank and ball detent recess.

1. To **install** the bit, press the bit into the socket until the collar snaps back and the bit is locked into place.
2. To **remove** the bit, pull out the collar, then pull out the bit.

**NOTE:** It is **not** necessary to hold the collar out when installing bits. The first time the tool is used, it may be necessary to pull out the collar.

The torque specifications shown here are approximate values obtained with a fully charged battery pack.

Torque Specifications			
Clutch Setting	in. lbs	Nm	Applications
1-5	5-15	0.1-1.7	Small screws in softwood.
6-10	16-22	1.8-2.48	Medium screws in softwood or small screws in hardwood.
11-15	23-28	2.6-3.2	Large screws in softwoods. Medium screws in hardwood or large screws in hardwood with pilot hole.
16-18	29-40	3.3-4.5	

**NOTE:** Because the settings shown in the table are only a guide, use a piece of scrap material to test the different clutch settings before driving screws into the workpiece.

### Selecting Speed

The speed selector is on top of the motor housing. Allow the tool to come to a complete stop before changing speeds. See "Applications" for recommended speeds under various conditions.

1. For **Low** speed, push the speed selector to display "1".
2. For **High** speed, push the speed selector to display "2".

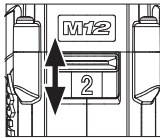

### Using the Control Switch

The control switch may be set to three positions: forward, reverse and lock. Due to a lockout mechanism, the control switch can only be adjusted when the ON/OFF switch is not pressed. Always allow the motor to come to a complete stop before using the control switch.

For **forward** (clockwise) rotation, push in the control switch from the right side of the tool. **Check the direction of rotation before use.**

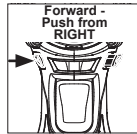

For **reverse** (counterclockwise) rotation, push in the control switch from the left side of the tool. **Check direction of rotation before use.**

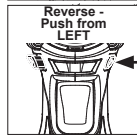

To **lock** the trigger, push the control switch to the center position. The trigger will not work while the control switch is in the center locked position. Always lock the trigger or remove the battery pack before performing maintenance, changing accessories, storing the tool and any time the tool is not in use.



### Starting, Stopping and Controlling Speed

1. To **start** the tool, grasp the handle firmly and pull the trigger.  
NOTE: An LED is turned on when the trigger is pulled.
2. To **vary** the speed, increase or decrease the pressure on the trigger. The further the trigger is pulled, the greater the speed.
3. To **stop** the tool, release the trigger. Make sure the bit comes to a complete stop before laying the tool down.

### Battery Pack Protection

To protect the battery from damage and extend its life, the tool's intelligent circuit monitors current draw, temperature, and voltage drops.

In extremely high torque, binding, stalling, and short circuit situations that cause high current draw, the tool will vibrate for about 5 seconds, the fuel gauge will flash, and then the tool will turn OFF. To reset, release the trigger.

Under extreme circumstances, the internal temperature of the battery could become too high. If this happens, the fuel gauge will flash and the battery pack will shut off. Let the battery pack cool and then continue work.

## APPLICATIONS

 **WARNING** To reduce the risk of electric shock, check work area for hidden pipes and wires before drilling or driving screws.

### Drilling in Wood, Composition Materials and Plastic

When drilling in wood, composition materials and plastic, • tart the drill slowly, gradually increasing speed as you drill. When drilling into wood, use wood augers or twist drill bits. Always use sharp bits. When using twist drill bits, pull the bit out of the hole frequently to clear chips from the bit flutes. To reduce the chance of splintering, back work with a piece of scrap wood. Select low speeds for plastics with a low melting point.

### Drilling in Metal

When drilling in metal, use high speed steel twist drills or hole saws. Use a center punch to start the hole. Lubricate drill bits with cutting oil when drilling in iron or steel. Use a coolant when drilling in nonferrous metals such as copper, brass or aluminum. Back the material to prevent binding and distortion on breakthrough.

### Driving Screws and Nut Running

Drill a pilot hole when driving screws into thick or hard materials. Set the torque selector collar to the proper position and set the speed to low. Use the proper style and size screwdriver bit for the type of screw you are using. With the screwdriver bit in the screw, place the tip of the screw on the workpiece and apply firm pressure before pulling the trigger. Screws can be removed by reversing the motor.

### Overloading

Continuous overloading may cause permanent damage to tool or battery pack.

## MAINTENANCE

 **WARNING** To reduce the risk of injury, always unplug the charger and remove the battery pack from the charger or tool before performing any maintenance. Never disassemble the tool, battery pack or charger. Contact a MILWAUKEE® service facility for ALL repairs.

### Maintaining Tool

Keep your tool, battery pack and charger in good repair by adopting a regular maintenance program. After six months to one year, depending on use, return the tool, battery pack and charger to a MILWAUKEE® service facility for:

- Lubrication

- Mechanical inspection and cleaning (gears, spindles, bearings, housing, etc.)
- Electrical inspection (battery pack, charger, motor)
- Testing to assure proper mechanical and electrical operation

If the tool does not start or operate at full power with a fully charged battery pack, clean the contacts on the battery pack. If the tool still does not work properly, return the tool, charger and battery pack to a MILWAUKEE® service facility for repairs.

 **WARNING** To reduce the risk of personal injury and damage, never immerse your tool, battery pack or charger in liquid or allow a liquid to flow inside them.

### Cleaning

Clean dust and debris from charger and tool vents. Keep tool handles clean, dry and free of oil or grease. Use only mild soap and a damp cloth to clean the tool, battery pack and charger since certain cleaning agents and solvents are harmful to plastics and other insulated parts. Some of these include petrol, turpentine, lacquer thinner, paint thinner, chlorinated cleaning solvents, ammonia and household detergents containing ammonia. Never use flammable or combustible solvents around tools.

### Repairs

For repairs, return the tool, battery pack and charger to the nearest service center, please visit [www.milwaukeetools.com.au](http://www.milwaukeetools.com.au) / [www.milwaukeetools.co.nz](http://www.milwaukeetools.co.nz) or contact our customer service centre (Australia Toll Free Telephone Number 1300 361 505) (New Zealand Toll Free Telephone Number 0800 279 624).

## ACCESSORIES

 **WARNING** Always remove battery pack before changing or removing accessories. Only use accessories specifically recommended for this tool. Others may be hazardous.

For a complete listing of accessories refer to your MILWAUKEE® Electric Tool catalog or go online to [www.milwaukeetool.com](http://www.milwaukeetool.com). To obtain a catalog, contact your local distributor or service center.

**WARRANTY - AUSTRALIA and NEW ZEALAND**

Please refer to the Techtronic Industries Pty. Ltd. Warranty Terms and Conditions for **MILWAUKEE®** products and accessories which is supplied with the tool or kit. This warranty applies only to product purchased from an authorised **MILWAUKEE®** dealer in Australia or New Zealand.

**AUSTRALIA AND NEW ZEALAND  
MILWAUKEE® Service**

**MILWAUKEE®** prides itself in producing a premium quality product that is Nothing But Heavy Duty®. Your satisfaction with our products is very important to us! If you encounter any problems with the operation of this tool, please contact your authorised **MILWAUKEE®** dealer or service centre.

For a list of **MILWAUKEE®** dealers, guarantee or service agents please contact **MILWAUKEE®** Customer Service or visit our website.

(Australia Toll Free Telephone Number 1300 361 505)

(New Zealand Toll Free Telephone Number 0800 279 624) or visit [www.milwaukeetools.com.au](http://www.milwaukeetools.com.au) / [www.milwaukeetools.co.nz](http://www.milwaukeetools.co.nz).

**Milwaukee Electric Tool Corporation**

13135 West Lisbon Road, Brookfield, Wisconsin U.S.A. 53005

**Milwaukee Electric Tool Corporation (Australia)**

Techtronic Industries (Australia) Pty. Ltd.  
Doncaster, Victoria, Australia, 3108

**Milwaukee Electric Tool Corporation (New Zealand)**

Techtronic Industries (New Zealand) Pty. Ltd.  
Mangere, Auckland, New Zealand, 2022

Professionally made in China for Milwaukee Electric Tool Corporation

961011349-01(A)